



US00D847814S

(12) **United States Design Patent**
Yoon et al.

(10) **Patent No.:** **US D847,814 S**

(45) **Date of Patent:** **** May 7, 2019**

(54) **DISPLAY DEVICE**

(71) Applicant: **Samsung Display Co., Ltd.**, Yongin-si, Gyeonggi-do (KR)

(72) Inventors: **Dae Ho Yoon**, Seoul (KR); **Seong Jin Hwang**, Suwon-si (KR)

(73) Assignee: **Samsung Display Co., Ltd.**, Yongin-si (KR)

(**) Term: **15 Years**

(21) Appl. No.: **29/619,402**

(22) Filed: **Sep. 28, 2017**

(30) **Foreign Application Priority Data**

Mar. 31, 2017 (KR) 30-2017-0015028

(51) **LOC (11) Cl.** **14-02**

(52) **U.S. Cl.**
USPC **D14/371**

(58) **Field of Classification Search**
USPC D14/371-375, 125-129, 336, 337;
D6/300, 308; D19/113, 114; D20/10;
361/679.27

(Continued)

(56) **References Cited**

U.S. PATENT DOCUMENTS

7,714,801 B2* 5/2010 Kimmel G06F 1/1616
345/1.3

8,493,730 B2 7/2013 Shim et al.
(Continued)

FOREIGN PATENT DOCUMENTS

KR 10-2016-0004316 A 1/2016
KR 10-2016-0025888 A 3/2016

(Continued)

Primary Examiner — Brandon M Rosati

(74) *Attorney, Agent, or Firm* — Lewis Roca Rothgerber Christie LLP

(57) **CLAIM**

The ornamental design for a display device, as shown and described.

DESCRIPTION

FIG. 1 is a front-top perspective view of a display device in a folded state;

FIG. 2 is a front view of the display device in the folded state;

FIG. 3 is a rear view of the display device in the folded state;

FIG. 4 is a left-side view of the display device in the folded state;

FIG. 5 is a right-side view of the display device in the folded state;

FIG. 6 is a top view of the display device in the folded state;

FIG. 7 is a bottom view of the display device in the folded state;

FIG. 8 is a front-top perspective view of the display device in an unfolded state;

FIG. 9 is a front view of the display device in the unfolded state;

FIG. 10 is a rear view of the display device in the unfolded state;

FIG. 11 is a left-side view of the display device in the unfolded state;

FIG. 12 is a right-side view of the display device in the unfolded state;

FIG. 13 is a top view of the display device in the unfolded state;

FIG. 14 is a bottom view of the display device in the unfolded state;

FIG. 15 is a front-top perspective view of the display device in the folded state and having an image displayed thereon; and,

FIG. 16 is a front-top perspective view of the display device in the unfolded state and having an image displayed thereon.

The broken lines shown in the drawings form no part of the claimed design.

1 Claim, 12 Drawing Sheets

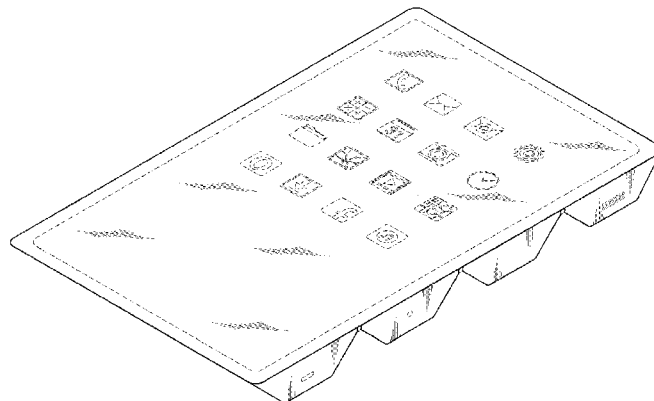
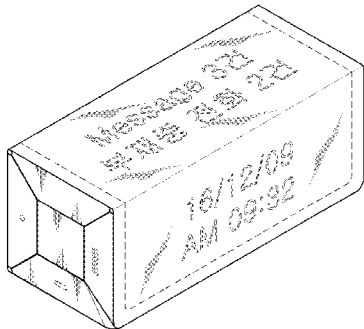

(58) **Field of Classification Search**

CPC G09F 15/0025; G09F 15/0062; G09F 15/0068; G09F 19/00; G09F 9/33; G06F 1/16; G06F 1/1613; G06F 1/133308; G06F 1/1601; G06F 3/037; G06F 1/162; G06F 1/1616; G06F 1/1647; G06F 1/1652; G06F 1/1681; F16M 11/02; F16M 11/10; F16M 11/00; F16M 11/06; F16M 11/18; F16M 11/045; F16M 11/105; F16M 11/041; F16M 11/126; F16M 11/04; F16M 11/24; F16M 13/02; A47F 5/00; G03B 21/145; G02F 1/33305

See application file for complete search history.

(56) **References Cited**

U.S. PATENT DOCUMENTS

8,587,539 B2 11/2013 Tziortzis et al.
 D694,754 S * 12/2013 Nakada D14/373
 8,896,202 B2 11/2014 Oh
 D719,542 S 12/2014 Lee et al.
 8,908,365 B2 * 12/2014 Walters G09F 19/00
 312/319.2
 9,052,769 B2 6/2015 Choi et al.
 D745,006 S 12/2015 Hirakata et al.
 D745,516 S 12/2015 Yamazaki et al.
 D750,036 S 2/2016 Endo et al.
 D750,064 S 2/2016 Yamazaki et al.
 D757,723 S 5/2016 Kwak et al.
 D760,218 S 6/2016 Yamazaki

D761,251 S 7/2016 Senda
 D761,252 S 7/2016 Senda
 D761,253 S 7/2016 Yamazaki
 D761,254 S 7/2016 Yamazaki et al.
 D761,787 S 7/2016 Yamazaki
 D761,788 S 7/2016 Yamazaki
 D761,789 S 7/2016 Yamazaki
 D761,790 S 7/2016 Yamazaki
 9,430,184 B2 * 8/2016 Cho G06F 1/1652
 D767,526 S 9/2016 Lee et al.
 D767,530 S 9/2016 Bae et al.
 D789,925 S * 6/2017 Browning D14/341
 2010/0157518 A1 * 6/2010 Ladouceur G06F 1/1616
 361/679.09
 2013/0342090 A1 * 12/2013 Ahn G09F 9/33
 312/258
 2014/0218321 A1 8/2014 Lee et al.
 2014/0321072 A1 10/2014 Cavallaro et al.
 2014/0347806 A1 * 11/2014 Totani G06F 1/1647
 361/679.27
 2015/0109544 A1 * 4/2015 Yeo G02F 1/133305
 349/12
 2015/0146386 A1 5/2015 Namkung et al.
 2015/0146387 A1 5/2015 Lee

FOREIGN PATENT DOCUMENTS

KR 10-2016-0055416 A 5/2016
 KR 10-2016-0074815 A 6/2016
 KR 10-2016-0080034 A 7/2016
 KR 10-2016-0103599 A 9/2016

* cited by examiner

FIG. 1

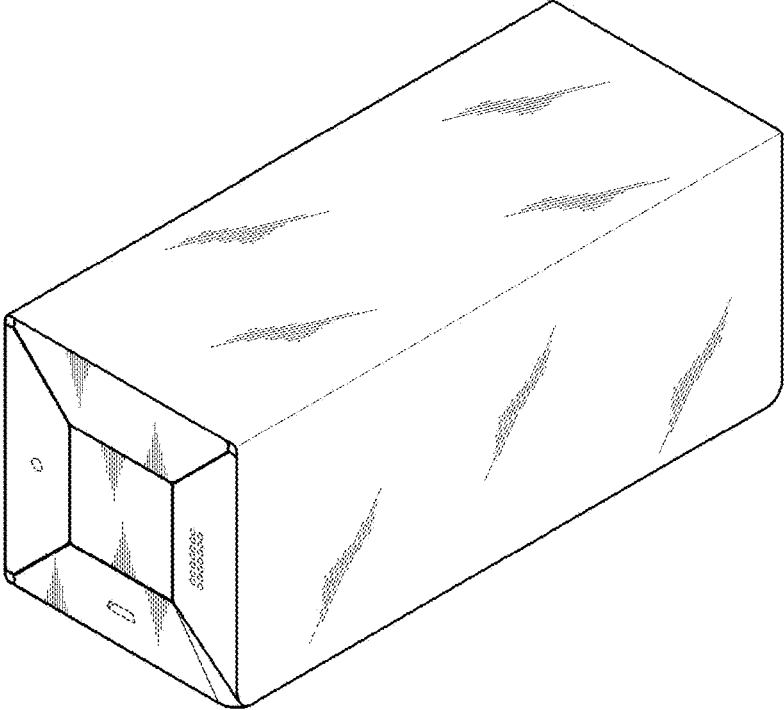

FIG. 2

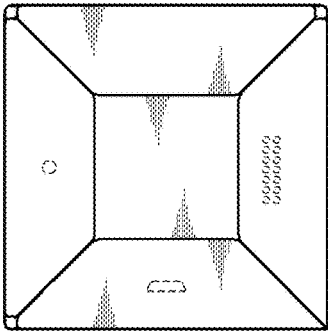

FIG. 3

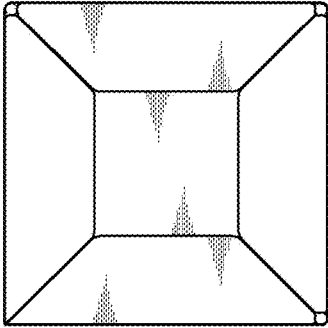

FIG. 4

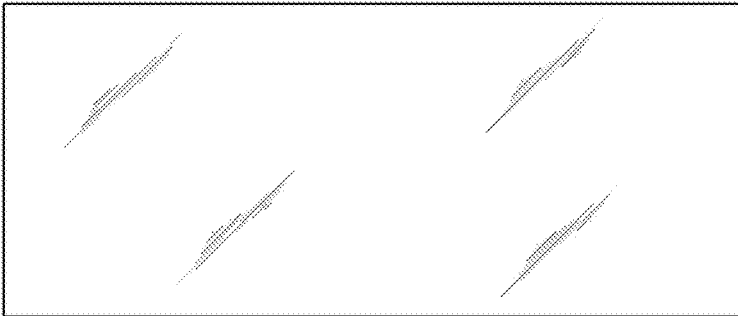

FIG. 5

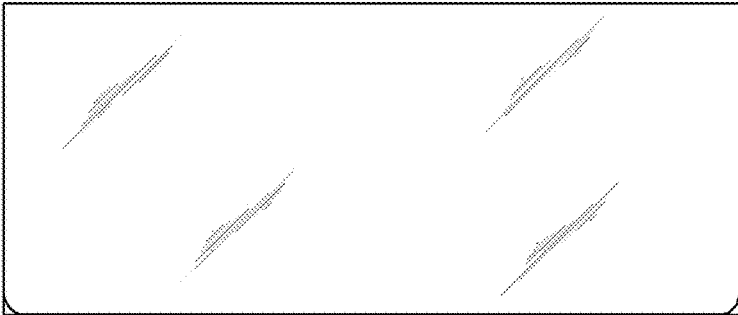

FIG. 6

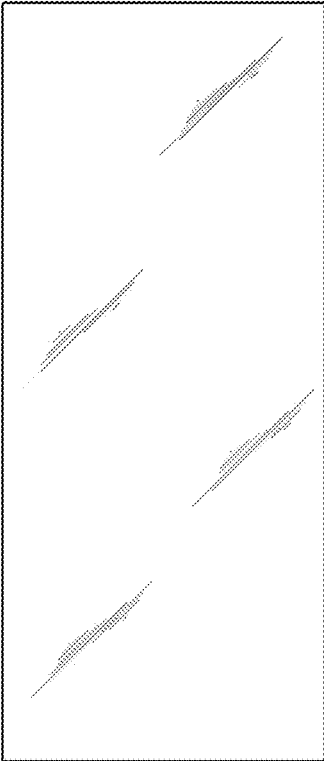

FIG. 7

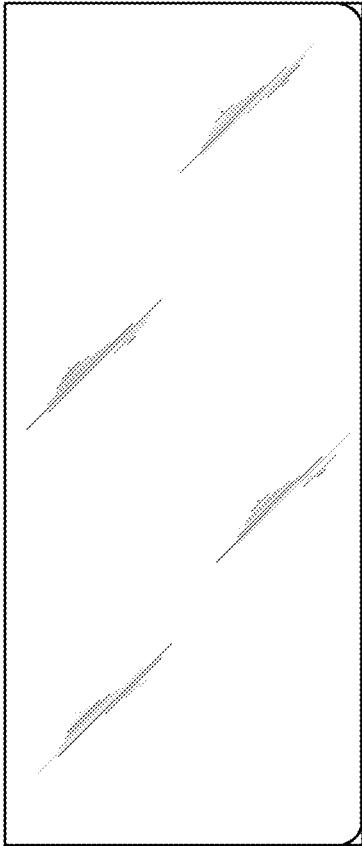

FIG. 8

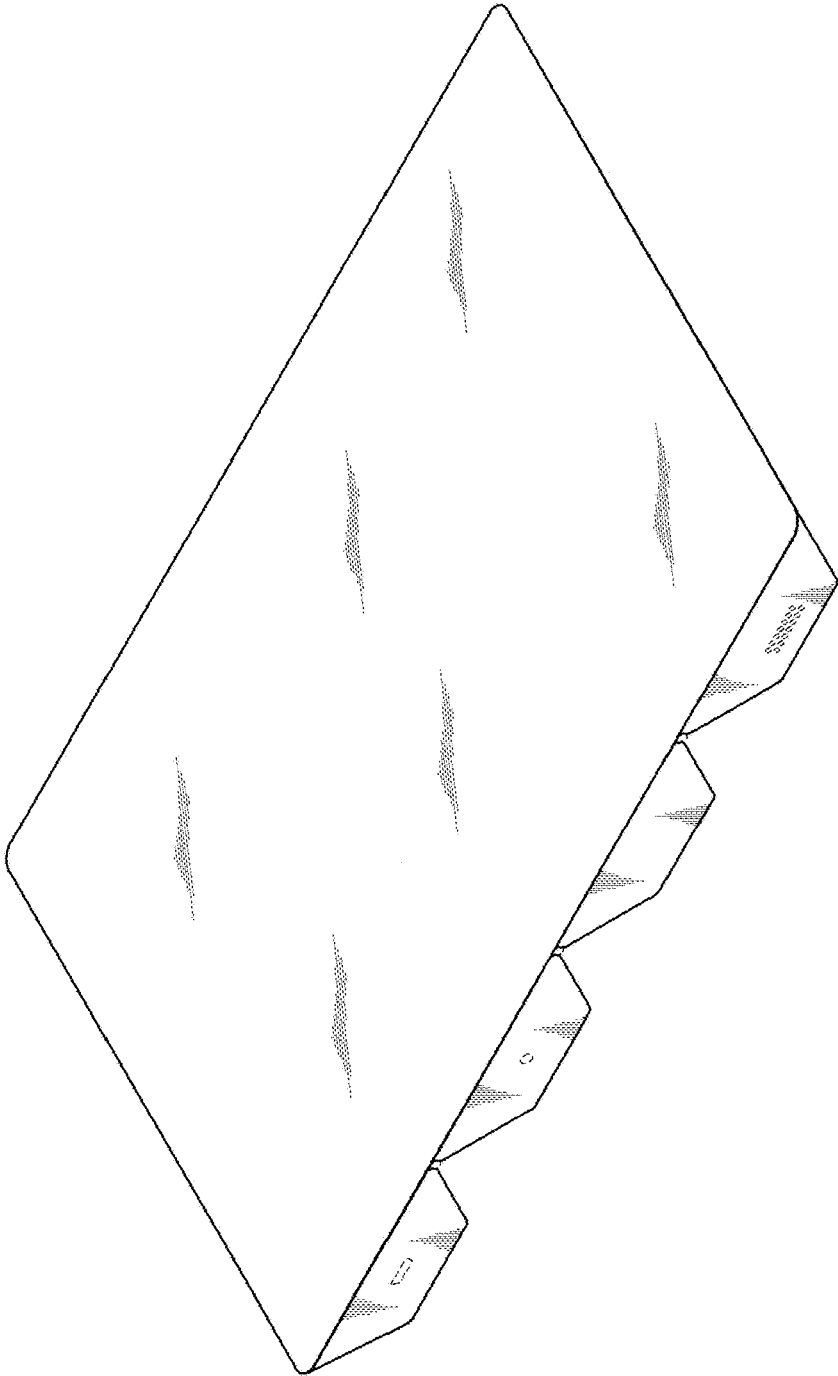

FIG. 9

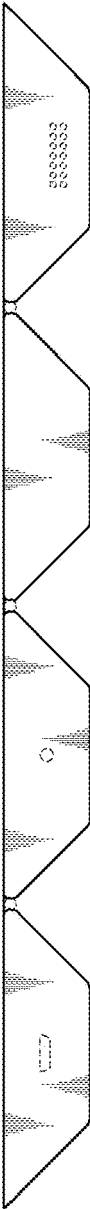

FIG. 10

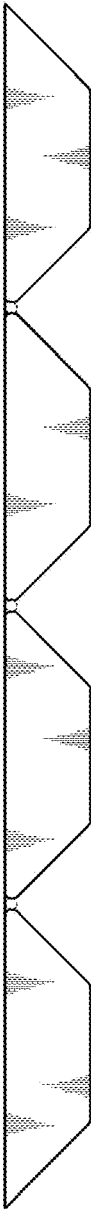

FIG. 11



FIG. 12



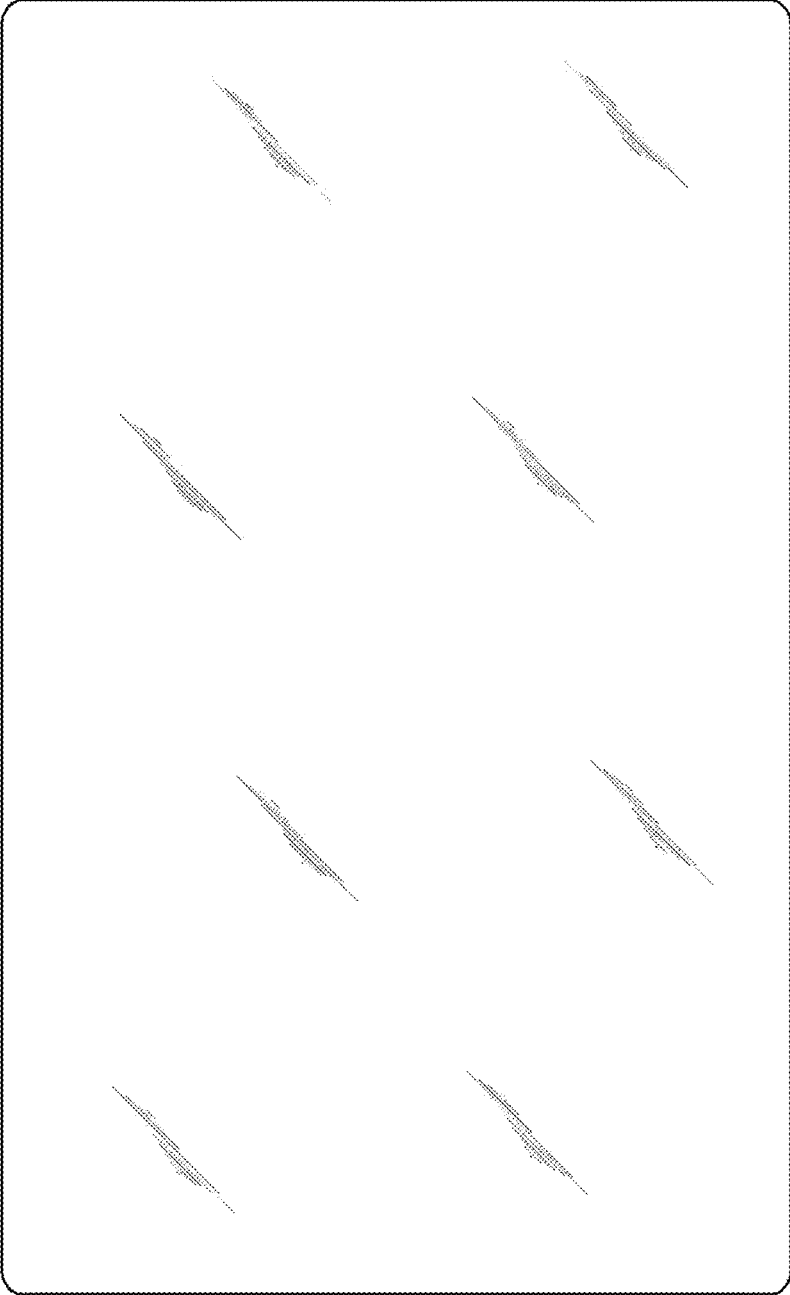

FIG. 13

FIG. 14

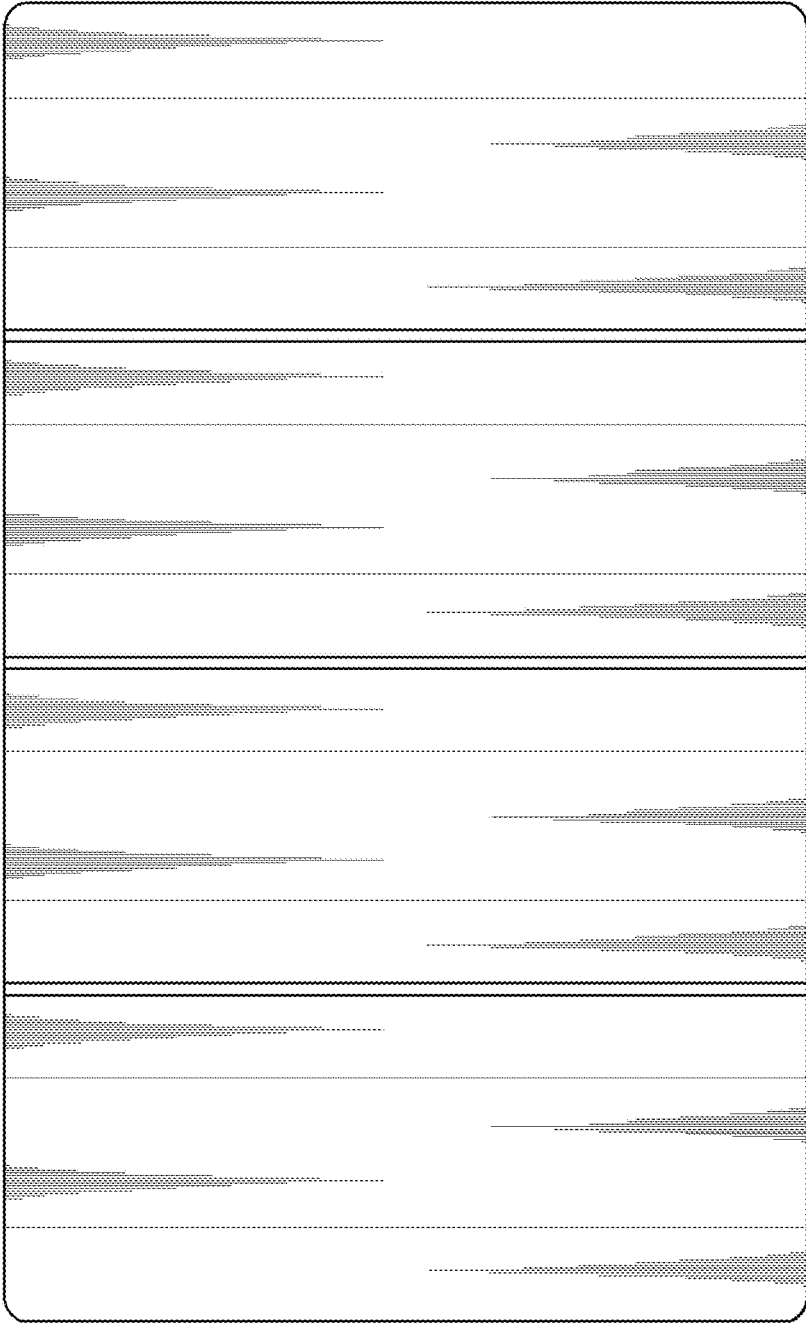

FIG. 15

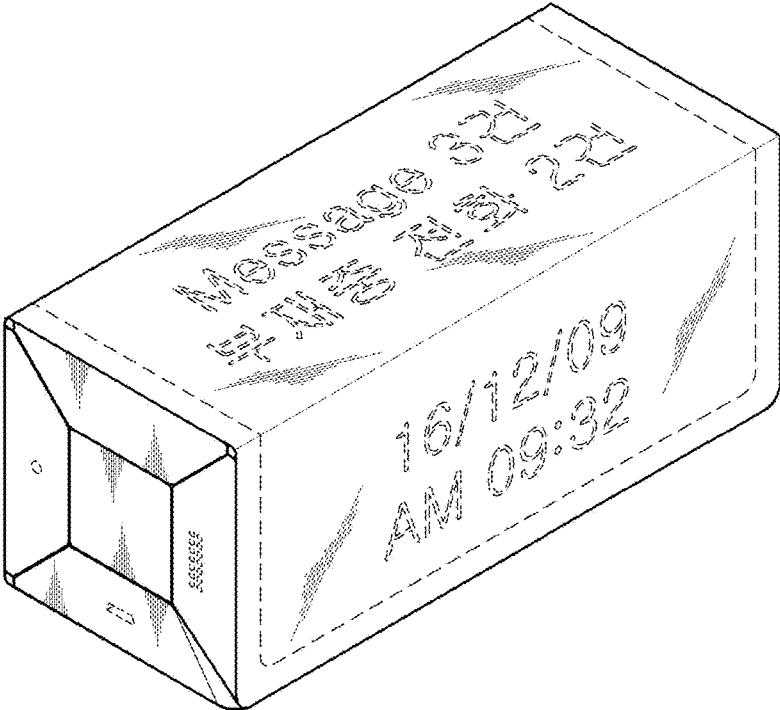

FIG. 16

